

**ILF ALPHA** 173HP



**ENERGREEN**®  
Professional Machines

SELF-PROPELLED  
HYDROSTATIC  
MACHINES



**ILF** SEMOVENTI  
SELF-PROPELLED

**MACCHINE SEMOVENTI IDROSTATICHE**  
SELF-PROPELLED HYDROSTATIC MACHINES

*New*





CABINA  
ROTANTE DI 90°  
90° ROTATING  
CABIN

# BRUSHCUTTER

**Energreen** presenta la nuova macchina semovente **ILF Alpha**.

Una macchina di altissimo livello tecnologico che garantisce prestazioni, sicurezza e flessibilità operativa.

Nata da un progetto pluripremiato e riconosciuto dai più grandi utilizzatori del settore della manutenzione del verde.

**ILF Alpha** non abbandona le caratteristiche che hanno reso uniche queste macchine porta-attrezzi con braccio telescopico, come: la visibilità, la multifunzionalità, l'agilità, le performance, ecc.

**ILF Alpha** può essere configurata con 3 tipologie di braccio di varie lunghezze che dispongono a sua volta di svariate attrezzature applicabili.

## ILF ALPHA

### Decespugliatrice con Braccio Multifunzione

### Brushcutter with Multifunction Arm

**Energreen** presents the new self-propelled hydrostatic machine **ILF Alpha**.

A high technology level machine that guarantees high performances, safety and working flexibility.

Born from an award-winning project recognized by the biggest customer of the green maintenance,

**ILF Alpha** does not lose the features which has made unique these tool carrier machines with telescopic arm: visibility, multifunctionality, ability, performance etc.

**ILF Alpha** can be equipped with 3 different types of arm with different lengths which have various equipment.





# STRENGTHS

## ILF ALPHA



### Sicurezza e Comfort

- Cabina rotante di 90° omologata FOPS-ROPS
- Vetro panoramico ad alta visibilità
- Ottima ergonomia di lavoro
- Controllo della stabilità SCD

### Safety and Comfort

- 90° rotating cabin homologated FOPS-ROPS
- High visibility panoramic windscreen
- Excellent working ergonomics
- SCD Stability Control Device



### Qualità

- Display LCD da 10" ECI *Energreen Control Interface*
- Potente motore JD da 173 CV Stage V
- Elementi strutturali in acciaio speciale
- Emissioni a norma EU Stage V
- Trasmissioni idrostatiche Heavy Duty

### Quality

- 10" LCD Display ECI *Energreen Control Interface*
- JD 173 HP Stage V powerful engine
- Main parts made with special steel
- EU Stage V emission
- Heavy Duty hydrostatic transmissions

## PUNTI DI FORZA STRENGTHS



### Multifunzionale

- Tre tipologie di braccio: T, F, 3P
- Numerose attrezzature applicabili
- Cura del verde, lavori forestali, viabilità invernale
- Attacchi per attrezzature anteriori e posteriori

### Multifunction

- Three types of arm: T, F, 3P
- Many tools available
- Green maintenance, forestry work, winter viability
- Front and rear attachment for tools



### Produttività

- Robusti e versatili bracci telescopici
- Lavoro bidirezionale
- Attività con più attrezzature in combinata
- Facile e intuitiva da utilizzare
- Visibilità in cabina a 360°

### Productivity

- Sturdy and flexible telescopic arms
- Bidirectional work
- Activity with several combined tools
- Easy and smart to use
- 360° cabin visibility

# ARM



## 3 DIVERSE GEOMETRIE DI BRACCIO THREE DIFFERENT ARM SHAPES



BRACCIO ARM **F**



BRACCIO ARM **T**



BRACCIO ARM **3P**



Display LCD ECI *Energreen Control Interface*

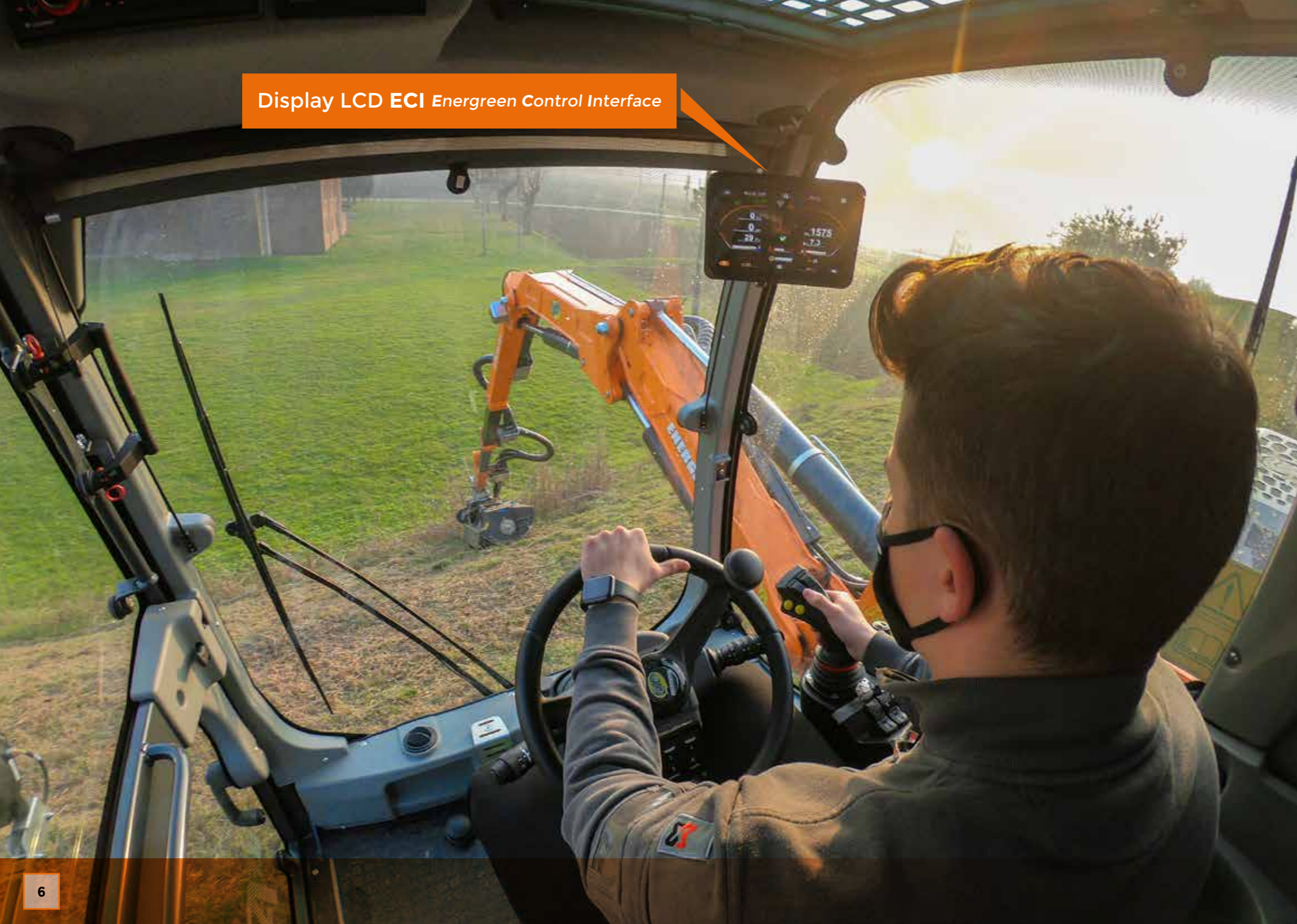

# 360° VISIBILITY

La visibilità è un elemento fondamentale per un corretto e sicuro utilizzo della macchina durante il lavoro e il trasferimento.  
Energreen fa da sempre di questo requisito uno dei suoi punti di forza!

ILF Alpha ha una cabina ampia e confortevole, dotata di un parabrezza di grandi dimensioni che consente all'operatore di avere una valida e totale visuale del proprio lavoro senza trascurare il proprio comfort e benessere fisico.

La cabina è certificata in termini di sicurezza dai collaudi FOPS-ROPS contro il rischio di capovolgimento e contro il rischio di caduta oggetti, è adeguatamente insonorizzata, provvista di un efficiente sistema di climatizzazione e dotata di tutti quei requisiti necessari ad assicurare all'operatore un ambiente di lavoro sicuro e confortevole.

La **rotazione della cabina di 90°** consente lo sfalcio dell'erba in entrambi i sensi di marcia, con una notevole riduzione dei tempi di lavoro e consumi di carburante.

La cabina ruotata permette di mantenere una postura del corpo sempre corretta, evitando stress e problemi alla schiena o al collo, oltre che a gestire in grande comfort e attenzione il lavoro svolto.

## Visibilità completa dell'ambiente di lavoro

## Complete visibility of the working environment

Visibility is an essential element for a correct and safe use of the machine while working and moving.  
Visibility has always been one of Energreen strengths!

ILF Alpha has a comfortable and spacious cabin, equipped with a large windscreen which allows the operator to have an efficient and total view of the work, keeping a high level of comfort and physical wellness.

In terms of safety, the cabin is certified by FOPS-ROPS tests: anti-tipping, against the risk of falling objects, soundproofed, provided with an efficient cooling system, and equipped with all that features necessary to assure the operator a safe and comfortable working environment.

The **90° rotation of the cab** makes the cut of the grass on both directions much easier. The rotating cabin allows the operator to always keep the correct body posture, avoiding stress and backpain or stiff neck, as well as managing the work with great comfort and care.

CABINA ROTANTE ROTATING CABIN

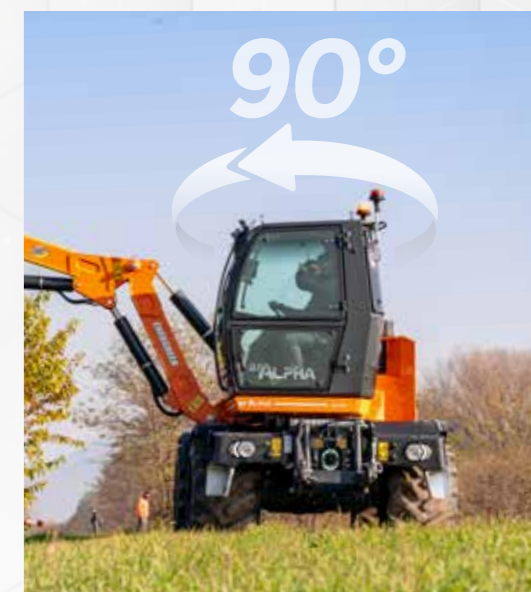



# CABIN COMFORT



La cabina della **ILF Alpha** è omologata FOPS-ROPS garantendo la protezione contro ribaltamenti e cadute di oggetti. Essa è dotata di un sistema di sigillatura, attraverso morbide guarnizioni sulle vetrate fisse e mobili, montata su supporti elastici nei punti di appoggio, risultando completamente isolata ed efficientemente climatizzata. Questa macchina multifunzione è adatta a lavori in ambienti polverosi e rumorosi per molte ore al giorno in completo comfort.

La cabina è disponibile in tre diversi allestimenti:  
**STANDARD - COMFORT - PRESTIGE**

## Massima Sicurezza e Comfort

## Maximum Safety and Comfort

**ILF Alpha** cabin is homologated according to the FOPS-ROPS regulation that guarantees the protection against overturning and objects fall. The cabin is completely isolated and efficiently air-conditioned thanks to a sealing system: soft gasket are settled on fixed and mobile glasses and the cabin is mounted on elastic supports on sustain points. In this way, this multifunction machine is suited for working in dusty and noisy environments for many hours per day, still keeping a high level of comfort.

The cabin is available in three versions:  
**STANDARD - COMFORT - PRESTIGE**

### CABINA/CABIN STANDARD

- Cabina girevole fino a 90°
- Omologazione cabina FOPS - ROPS
- Schermo ECI da 10"
- Colonna sterzo inclinabile e regolabile in altezza
- Comando inversione di marcia elettronico
- Bracciolo regolabile con Joystick
- Tergi lava-cristallo anteriore
- Aria condizionata con filtro anti-polline
- Tendina parasole auto-avvolgente anteriore
- Specchio SX
- Lampada rotante a LED
- Porta cabina con possibilità di apertura parziale
- Vetro posteriore oscurato anti UV parzialmente apribile
- Vano porta oggetti/documenti laterale
- Luci di cortesia a LED
- Martelletto frangi cristallo di emergenza
- Presa elettrica esterna per servizi 12 V
- Accendisigari 12 V
- Presa USB a due vie
- Appendi abiti
- Sedile GRAMMER MAXIMO XXL con sospensione pneumatica ed ammortizzatore lombare regolabili

- 90° rotating cabin
- FOPS-ROPS homologated cabin
- 10" ECI Display
- Tilting and height-adjustable steering column
- Electronic direction control lever
- Adjustable armrest with Joystick
- Front windshield washer wiper
- Air conditioning with anti-pollen filter
- Retractable sunshade on front windshield
- Left mirror
- Height-adjustable LED beacon
- Cabin door partially openable
- Darked anti-UV rear window, partially openable
- Lateral documents holder
- Automatic LED courtesy lights
- Emergency glass break hammer
- External electrical socket for 12 V services
- Internal 12 V DC socket
- Two-way USB socket
- Clothes hangers
- GRAMMER MAXIMO XXL seat with air suspension and adjustable lumbar shock absorber

### CABINA/CABIN COMFORT

- In aggiunta all'allestimento "CABINA STANDARD"**
- Cruise Control
  - Pedale inversione di marcia istantanea
  - Autoradio Bluetooth/DAB
  - Fari di lavoro a LED
- In addition to the «STANDARD CABIN» installation**
- Cruise Control
  - Instant reverse pedal
  - DAB/Bluetooth stereo
  - LED working lights

### CABINA/CABIN PRESTIGE

- In aggiunta all'allestimento "CABINA COMFORT"**
- N. 1 telecamera retromarcia (visualizzazione integrata nell'ECI)
  - 2° lampeggiante
  - Oblò sul tetto con grata, tendina e tergicristallo
  - Tergicristallo laterale destro
  - Estintore da 2 kg
  - Sedile GRAMMER MAXIMO EVOLUTION DYNAMIC con seduta maggiore, sospensione pneumatica, ammortizzatore longitudinale, sospensione laterale, ammortizzatore lombare e sistema di climatizzazione attiva
- In addition to the «COMFORT CABIN» installation**
- N. 1 reversing camera (integrated view in the ECI)
  - Twin LED beacon
  - Porthole with grille, curtain and windshield wiper.
  - Windshield wiper on the right side.
  - 2 kg fire extinguisher
  - GRAMMER MAXIMO EVOLUTION DYNAMIC seat with larger seat dimensions, air suspension system, longitudinal shock absorber, side suspension, lumbar shock absorber and active climate control system



**VOLANTE REGOLABILE**  
**ADJUSTABLE STEERING WHEEL**



**TELECAMERA RETROMARCIA**  
**REVERSING CAMERA**



**OBLÒ SUPERIORE CON GRATA**  
**TOP PORTHOLE WITH GRILLE**



# DISPLAY ECI

Il nuovo display a colori da 10 pollici (1) in combinata al nuovo Power Track, alle pulsantiere e al manipolatore danno vita al nuovo sistema ECI «Energreen Control Interface» esclusivo di Energreen. Questo sistema permette di controllare tutte le funzioni della macchina in modo semplice e intuitivo, personalizzando anche le schermate operative in base alle preferenze dell'operatore.

Per la navigazione all'interno del display interviene il Power Track (2). Completo di tasti multifunzione e manopola pushbutton, permette sia la rotazione, sia l'utilizzo della stessa come pulsante per gestire totalmente ogni funzionalità e parametro della macchina all'interno del display.

Infine il nuovo manipolatore (3) garantisce il controllo del braccio e dell'attrezzatura con la massima facilità e precisione.

## Il nuovo sistema di controllo ECI «Energreen Control Interface»

### The new control system ECI «Energreen Control Interface»

The new 10" colors display (1) together with the new Power Track, the button panel and the Joystick create the new ECI system «Energreen Control Interface», exclusive by Energreen.

This system allows to control all the functions of the machine in a simple and intuitive way, allowing also the customization of the screens based on the operator preferences.

The Power Track is used for surfing inside the display. It is composed by multifunction buttons and a pushbutton for managing every function of the machine from the display.

Finally, the new Joystick (3) assures the control of the arm and of the tool with ease and the maximum precision.

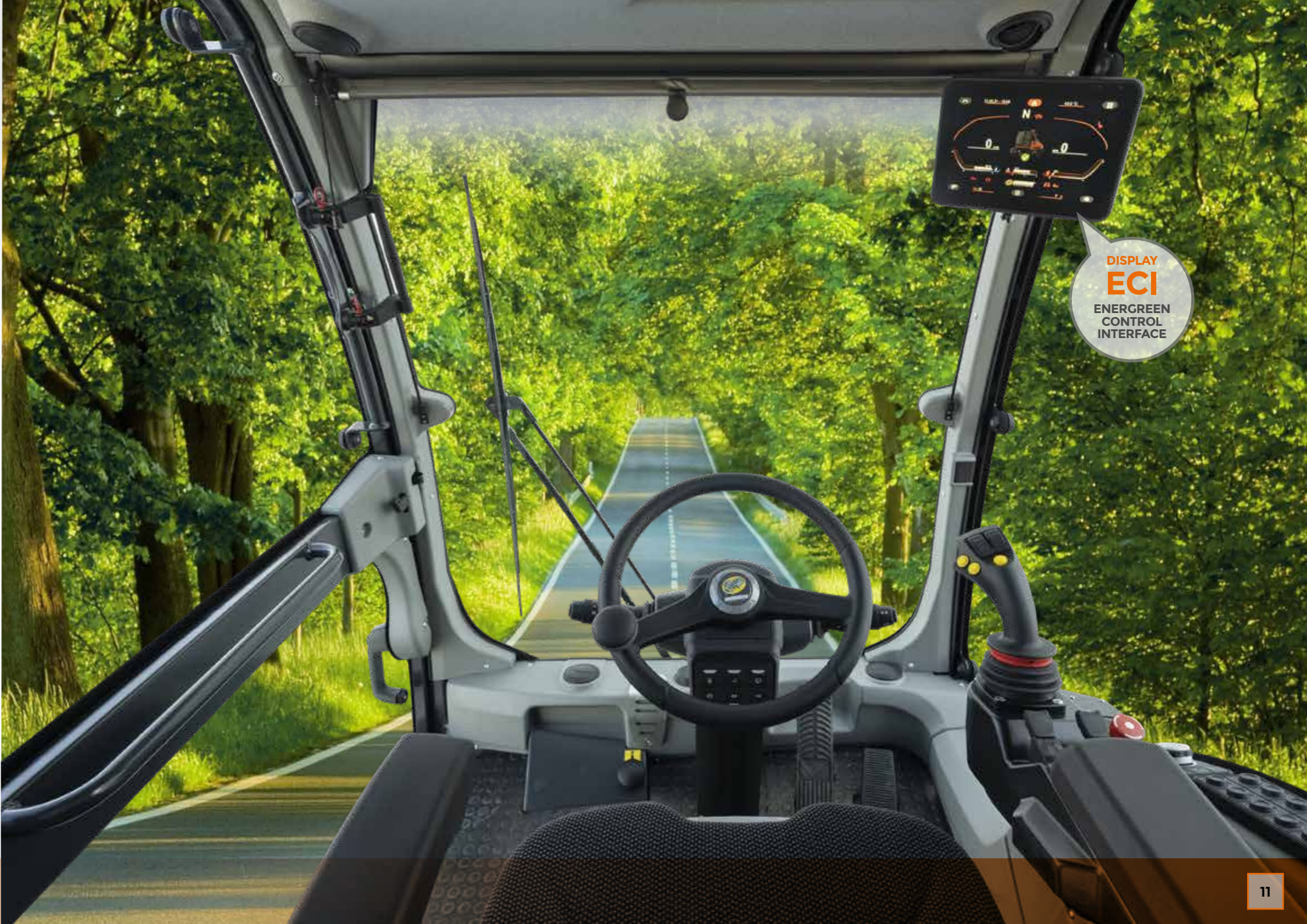

DISPLAY  
**ECI**  
ENERGREEN  
CONTROL  
INTERFACE





# TELESCOPIC ARM F



Il braccio telescopico **F** è adatto per il taglio dell'erba su bordi stradali oppure in aree strette; la sua particolare geometria facilita il superamento di ostacoli come ad esempio i segnali stradali. Braccio ideale anche per lavori di manutenzione e potatura aerea in posizione verticale.

*Modelli: F9,5 (9,5 metri) - F11 (11 metri) - F12 (12 metri)*

The telescopic arm **F** is ideal for grass cutting along roads or in narrow areas; its special shape makes the overcoming of obstacles - like road signals - easy and simple. It is also the ideal arm for aerial maintenance and pruning in vertical position.

*Models: F9,5 (9.5 meters) - F11 (11 meters) - F12 (12 meters)*

## CARATTERISTICHE FEATURES

- Braccio telescopico fino a 12 m.
- Adatto per bordi stradali o aree strette.
- Facile superamento di ostacoli.
- Potature di rami in posizione verticale.
- Versatilità di utilizzo con vari attrezzi.

- Telescopic arm up to 12 m.
- Appropriate for roadsides or narrow areas.
- Easy overcoming of obstacles.
- Cutting of branches in vertical position.
- Versatile use of various tools.

# F9.5

# F11

# F12

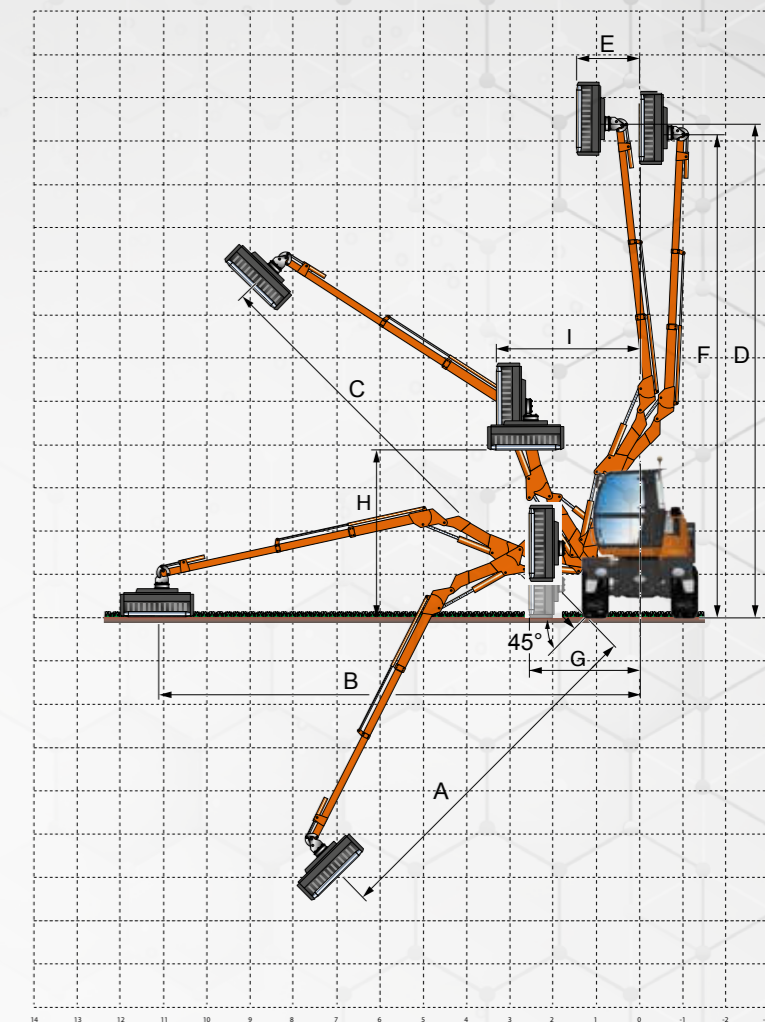

MOD.	A	B	C	D	E	F	G	H	I
F9.5	6,58	9,41	9,32	9,79	1,76	9,41	2,30	3,69	2,89
F11	8,30	11,11	11,02	11,48	1,62	11,31	2,46	3,90	2,96
F12	9,06	11,85	11,76	12,22	1,55	12,08	2,48	3,91	3,27



# T8 T10 T12

## TELESCOPIC ARM T



Il braccio telescopico **T** è robusto e versatile. È in grado di operare in sicurezza con ogni tipo di attrezzatura. Questo braccio è stato progettato per lavorare sia a lunga distanza per poter raggiungere gli spazi più lontani, sia per lavori a filo ruota in spazi ristretti.

Modelli: T8 (8 metri) · T10 (10 metri) · T12 (12 metri)

The telescopic arm **T** is sturdy and multifunction. It is able to safely work with every kind of equipment. This arm has been designed both for long distance activity and for working in narrow areas on the edge of the street.

Models: T8 (8 meters) · T10 (10 meters) · T12 (12 meters)

### CARATTERISTICHE FEATURES

- Braccio con estensione fino a 12 metri.
- Adatto per le lunghe distanze.
- Braccio lungo ma con dimensioni compatte.
- Taglio di rami in posizione verticale.
- Versatilità di utilizzo con vari attrezzi.

- Telescopic arm up to 12 m.
- Work on long distances.
- Extended arm but with compact dimensions.
- Cutting of branches in vertical position.
- Versatile use of various tools.

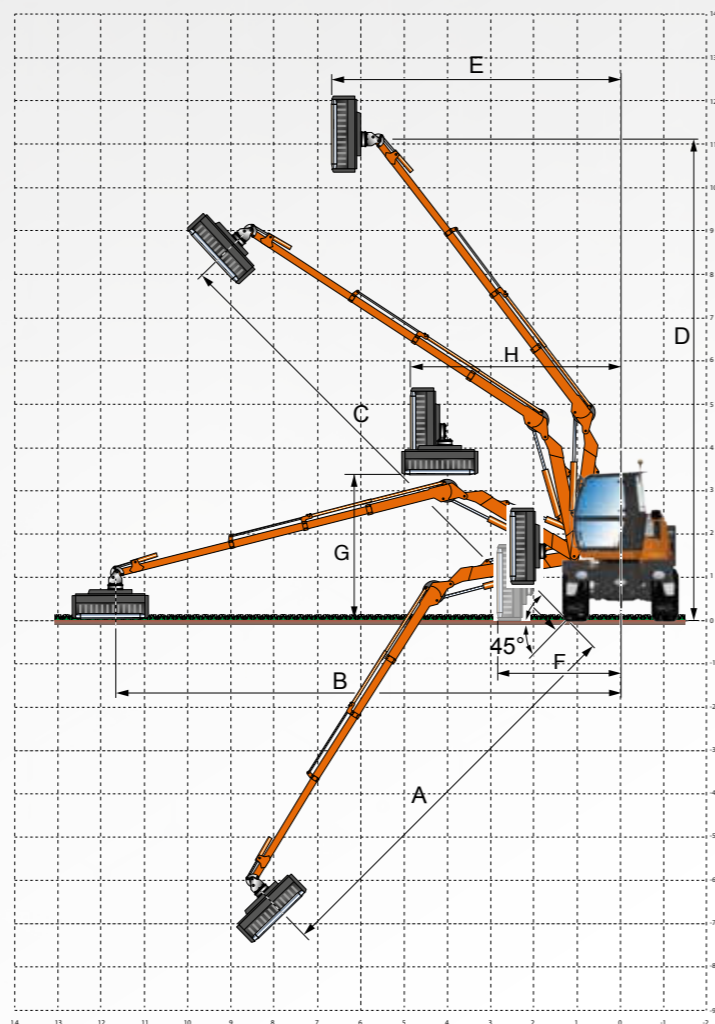

MOD.	A	B	C	D	E	F	G	H
T8	6,60	8,29	8,17	8,31	3,86	2,64	3,21	4,44
T10	7,94	10,04	9,95	9,75	5,12	2,70	3,53	4,62
T12	9,78	11,82	11,73	11,17	6,26	2,76	3,24	4,79

Caratteristiche tecniche e costruttive soggette a modifica senza obbligo di notifica - Technical and construction specifications may be subject to change without prior notice.

# 3P 9.7

## TELESCOPIC ARM 3P



Il braccio telescopico **3P** ha una struttura robusta e compatta divisa in 3 pezzi per consentire il superamento di ostacoli tipici del lavoro stradale. Inoltre la sua geometria lo rende adatto per utilizzare attrezzature come benne per la pulizia dei canali.

The telescopic arm **3P** has a sturdy and compact structure, divided in 3 pieces for allowing the overcoming of the typical obstacles when working along the routes. In addition, its geometry makes it ideal for working with tools like buckets for the cleaning of canals.

### CARATTERISTICHE FEATURES

- Braccio telescopico fino a 9,7 m.
- Adatto per bordi stradali o canali.
- Superamento di ostacoli.
- Movimento adatto all'uso di benne.
- Struttura robusta e compatta.

- Telescopic arm up to 9,7 m.
- Ideal for roadsides or canals.
- Overcoming of obstacles
- Ideal for working with buckets
- Sturdy and compact structure

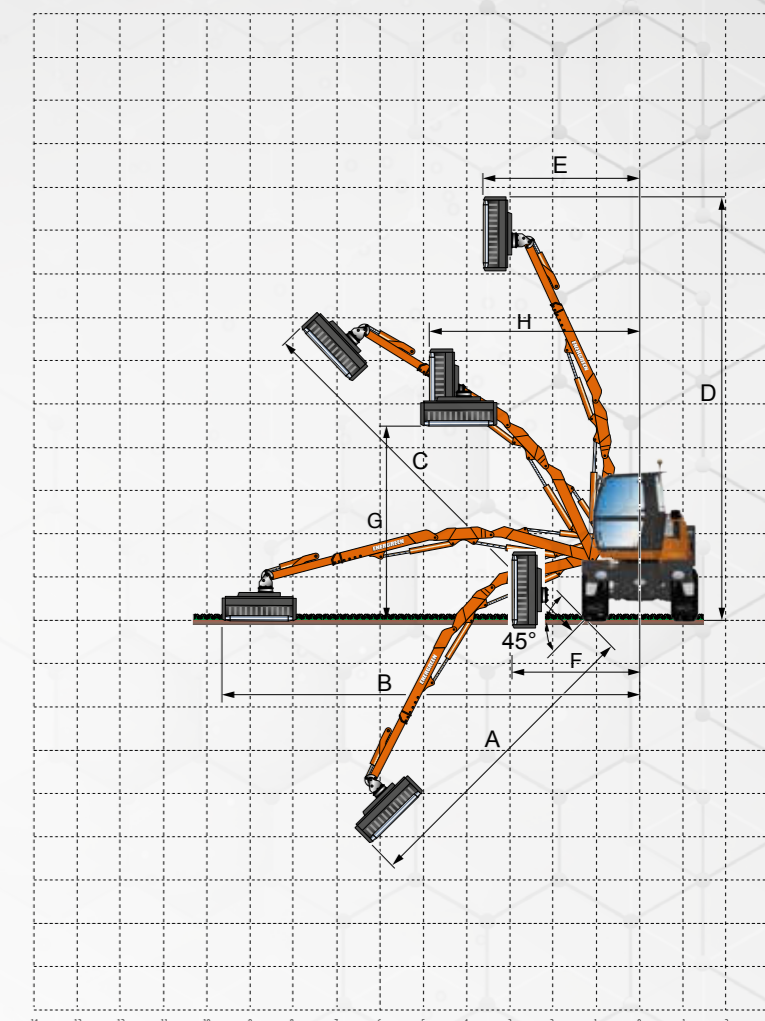

MOD.	A	B	C	D	E	F	G	H
3P 9.7	7,27	9,64	9,56	9,85	3,57	2,86	4,53	4,73

Caratteristiche tecniche e costruttive soggette a modifica senza obbligo di notifica - Technical and construction specifications may be subject to change without prior notice.





# ACCESSORIES

## A ATTACCO FRONTALE FRONT ATTACHMENT



"HERCULES"



DIN PLATE

## B ATTACCO POSTERIORE REAR ATTACHMENT



BLOWER



TOW HOOK

Sollevatore PTO (10 T.) / Lifter  
(optional)

Piastra DIN 76060 / Plate  
(optional)

Soffiatore / Blower  
(optional)

Gancio traino  
Tow hook

L'ATTREZZO ADATTO PER OGNI LAVORO



THE SUITABLE TOOL FOR EVERY WORK

C



**NEW SPEED**  
120 cm  
TESTATA TRINCIANTE  
CUTTING HEAD



**NEW SPEED**  
150 cm  
TESTATA TRINCIANTE  
CUTTING HEAD



**CONVEYOR HEAD**  
TESTATA TRINCIANTE  
CON NASTRO TRASPORTATORE  
CUTTING HEAD WITH CONVEYOR BELT



**FORESTRY HEAD**  
TESTATA TRINCIANTE FORESTALE  
A DENTI FISSI  
FORESTRY HEAD WITH FIXED TEETH



**SAW BAR**  
BARRA A DISCHI  
CUTTER DISCS BAR



**CUTTER BAR**  
BARRA FALCIANTE  
CUTTER BAR



**POWER SHEARS**  
TRONCARAMI  
POWER SHEARS



**IRON BRUSH**  
SPAZZOLA DI FERRO  
IRON BRUSH TO CLEAN ROADSIDE



**DITCH CLEANER**  
FRESA FOSSI  
SHEET DITCH CLEANER



**ORANGE PEEL GRAPPLE**  
PINZA A POLIPO  
ORANGE PEEL GRAPPLE



**TRUNK PINCERS**  
PINZA PER TRONCHI  
TRUNK PINCERS



**FORC-ONE**  
FORCA PER ERBA  
GRASS GRAB



**EXTRA TRUNK**  
FORBICE-PINZA PER POTATURA  
PRUNING SCISSORS-PINCERS



**STUMP GRINDER**  
FRESA CEPPI  
STUMP GRINDER



**RIVER BUCKET**  
BENNA FALCIANTE  
WEEDING-MOWING BUCKET



**DITCH BUCKET**  
PULIFOSSI  
DITCH CLEARING BUCKET

Solo per versione con braccio 3P - Only for 3P arm

A



**RAIBER**  
FALCIATRICE PER GUARDRAIL  
BARRIER MOWER

**TRANSFORMER 840**



**DISCOVERY 840**



**ROTATOR UNIT**  
RALLA PER LA ROTAZIONE DI 180° DELLA ATTREZZATURA  
ROTATOR UNIT FOR 180° EQUIPMENT ROTATION

EQUIPMENT



# MANOEUVRABILITY



**2 RUOTE STERZANTI ANTERIORI**  
2 FRONT STEERING WHEELS



**4 RUOTE STERZANTI IN TONDO**  
4-WHEEL STEERING



**4 RUOTE STERZANTI PARALLELE**  
4 PARALLEL STEERING WHEELS



La natura polivalente di questa macchina si evince anche dal sistema di trazione a 4 ruote motrici, tutte sterzanti, configurabili idraulicamente da comando in cabina in 3 diverse modalità operative:

- **2 ruote sterzanti anteriori**, per la massima agilità sui trasferimenti su strada.
- **4 ruote sterzanti**, sistema che dimezza il raggio di sterzata della macchina, adatto al lavoro in spazi ristretti.
- **4 ruote sterzanti parallele (a granchio)**, utile per movimentare particolari attrezzature o ad allontanarsi da un ostacolo.

## Agilità e Precisione nelle Manovre

## Agility and Precision in the Movements

The polyvalent soul of this machine is highlighted also from the 4-wheel drive traction system, all steering, hydraulically configurable from the cab control in 3 different operating modes:

- **2 front steering wheels**, for the maximum agility on the road movement.
- **4 steering wheels**, a system that halves the turning range of the machine, ideal for working in narrow areas.
- **4 parallel steering wheels (crab)**, useful when using a particular tool or for moving away from an obstacle.

# STABILITY

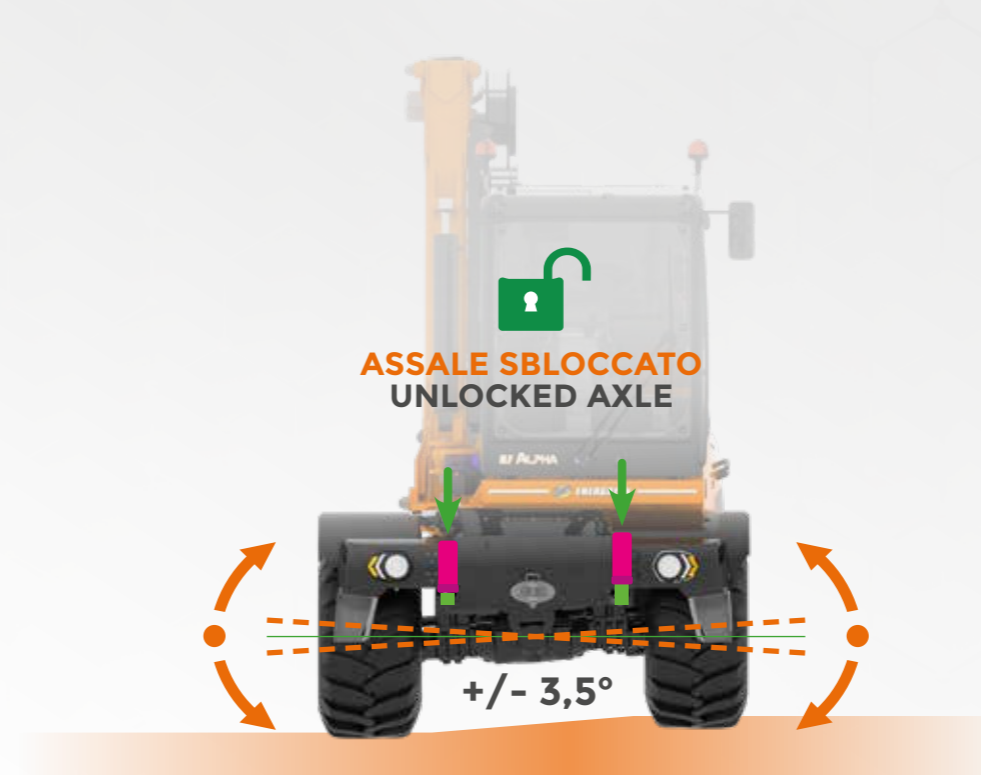

Il controllo della stabilità SCD permette il bloccaggio dell'oscillazione dell'assale anteriore incrementando notevolmente la stabilità della macchina, garantendo all'operatore il massimo della performance e della sicurezza. Questo plus è composto da due martinetti ad azionamento idraulico fissati al telaio della macchina, vengono completamente controllati dall'innovativo sistema ECI presente in cabina.

## Controllo della Stabilità SCD

## SCD Stability Control Device

The SCD Stability Control Device allows to lock the front axle oscillation, increasing the stability of the machine, in order to guarantee the maximum level of performance and safety for the operator. This plus is composed by two hydraulic jacks fixed on the chassis of the machine and controlled by the innovative ECI system inside the cab.

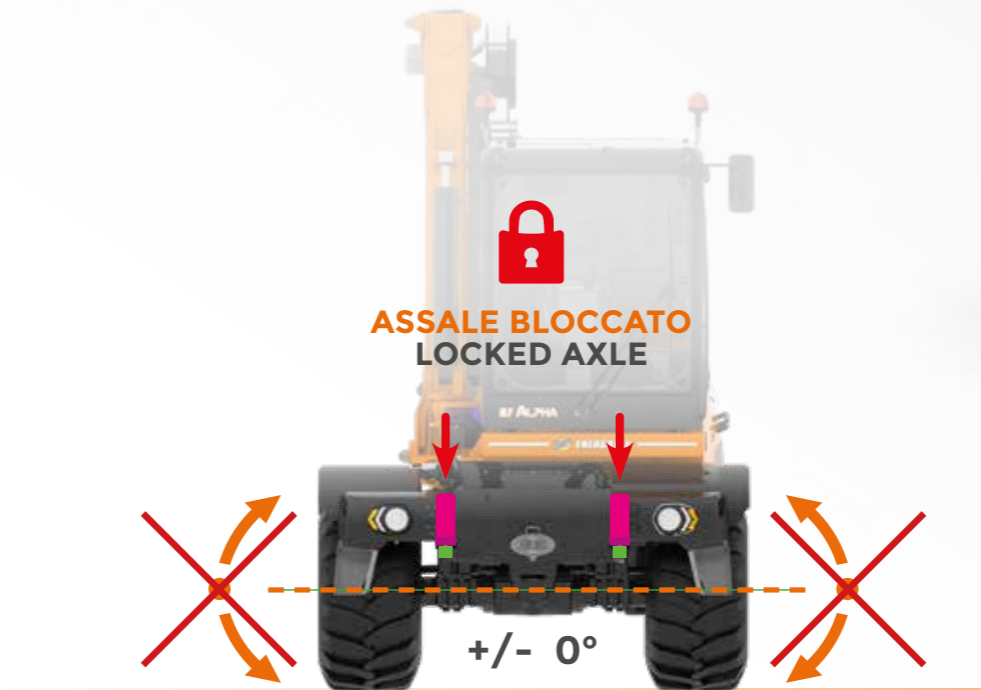



# ENGINE

## ILF ALPHA



ILF Alpha monta un motore John Deere 4.5 da 173 CV (129 kW), 4 cilindri in linea con raffreddamento a liquido, ricircolo dei gas di scarico ed emissioni conformi a normative EU Stage V.

Il potente sistema di iniezione Common Rail ad alta pressione con 4 valvole per cilindro e il controllo elettronico (EMR) con collegamento intelligente alla gestione del motore, garantiscono prestazioni ottimali con un basso consumo di carburante.

- Minimo consumo totale di liquidi operativi rispetto alla concorrenza.
- Supporto tecnico e diagnosi forniti dalla rete di assistenza mondiale di John Deere.

### Potente Motore John Deere

### John Deere Power Engine

ILF Alpha is equipped with a John Deere 4.5 with 173 HP (129 kW), 4-cylinder inline engine with liquid-cooled, external exhaust gas recirculation and EU Stage V emissions.

The powerful Common Rail injection system with high pressure with 2 valves per cylinder and the electronic engine control (EMR) with intelligent link to the drive management ensures optimum engine performance at low fuel consumption.

- Minimum consumption of operative liquids compared to competitors.
- Technical support and diagnosis provided by John Deere's worldwide service network.

FACILE ACCESSO  
ALLA MANUTENZIONE  
EASY ACCESS  
FOR MAINTENANCE



# JOHN DEERE 4.5



CINQUE IMPIANTI IDRAULICI INDIPENDENTI:  
1. TRASLAZIONE  
2. TESTATA TRINCIANTE  
3. STERZATURA  
4. FRENATURA  
5. FUNZIONI BRACCIO

FIVE INDEPENDENT HYDRAULIC SYSTEMS:  
1. MOVEMENT  
2. CUTTING HEAD  
3. STEERING  
4. BRAKING  
5. ARM FUNCTIONS

ASSE POSTERIORE FISSO  
FIXED REAR AXLE

TRAZIONE INTEGRALE  
4 WHEEL DRIVE

TRASMISSIONE IDROSTATICA  
HYDROSTATIC TRANSMISSION

BLOCCAGGIO DIFFERENZIALE ANTERIORE E POSTERIORE AL 100%  
100% FRONT AND REAR DIFFERENTIAL LOCKING

MARTINETTI DI BLOCCAGGIO OSCILLAZIONE  
JACK FOR OSCILLATION CONTROL

TELAIO HD-FRAME IN STRENX®  
HD-FRAME IN STRENX®

FILTRO IN ALTA PRESSIONE IN ENTRATA AL DISTRIBUTORE  
INLET HIGH PRESSURE FILTER TO THE DISTRIBUTOR

FRENO NEGATIVO DI STAZIONAMENTO (ANTERIORE)  
NEGATIVE PARKING BRAKE (FRONT AXLE)

FRENI IN BAGNO D'OLIO IN ENTRAMBI GLI ASSI  
BRAKE DISCS IN OIL BATH ON BOTH AXLES

# QUALITY



# EASY MAINTENANCE

Per andare incontro alle esigenze di produttività e sicurezza dei propri clienti, Energreen ha voluto integrare nella macchina semovente **ILF Alpha** un concetto di manutenzione ordinaria semplice, veloce ed efficace.

Tutti i punti strategici per i controlli quotidiani sono infatti facilmente accessibili e gestibili da terra: il vano motore e i vari compartimenti per il rifornimento dell'olio, gasolio e AdBlue sono a portata di mano.

Il tutto rende **ILF Alpha** una macchina d'avanguardia, dove l'operatività e il controllo dell'operatore sono messi al primo posto.

## Facile accesso alla manutenzione

## Easily accessible for maintenance

For meeting the productivity and safety needs of the clients, Energreen wanted to integrate in the self-propelled machine **ILF Alpha** a concept of ordinary maintenance which is simple, fast and efficient.

All the strategic points for the daily checks are easily accessible from the floor: the engine room and the various compartments for oil, diesel and AdBlue refueling are at hand.

All this makes **ILF Alpha** a cutting-edge machine, where the performance and the control of the operator are put in first place.



**VANO MOTORE FACILMENTE ACCESSIBILE PER LA MANUTENZIONE ORDINARIA E STRAORDINARIA**

**THE ENGINE COMPARTMENT IS EASILY ACCESSIBLE FOR ORDINARY AND EXTRAORDINARY MAINTENANCE**



**Maniglione Handle**

**Vano rifornimenti gasolio ed olio e manutenzione filtro Diesel and oil supply compartment and filter maintenance**

**Vano rifornimento AdBlue AdBlue supply compartment**

**Gradino integrato Integrated step**

**Gradino apribile Moving step**



OPTIONAL



## AUTO LUBE Ingrassaggio automatico Automatic greasing system

Il sistema **AUTO LUBE** è costituito da una pompa per grasso a funzionamento elettrico e gestione elettronica che le permette di lavorare autonomamente e di essere programmata al fine di garantire la migliore lubrificazione possibile di perni e boccole del braccio e dei cilindri idraulici. Inoltre, questo sistema consente una notevole riduzione dei tempi dedicati alla manutenzione ordinaria.

The **AUTO LUBE** system is built with an electric greasing pump, electronically controlled, that allows to work independently and to be programmed to ensure the best lubrication of pins and bushing of the arm and of hydraulic cylinders. Moreover, this system allows an important reduction of maintenance hours.



## Joystick semplice e intuitivo Simple and intuitive joystick

Manipolatore di alta qualità con controlli principali proporzionali che permette un controllo preciso e fluido delle attrezzature installate. Consente di muovere fino a 3 funzioni del braccio contemporaneamente con un'ottima gradualità dei movimenti.

High quality joystick with proportional main controls that allows a precise and smooth control of the equipments. It allows you to move up to 3 arm functions at the same time with an excellent gradual movement.

# TYRES

VASTA GAMMA DI PNEUMATICI  
SPECIFICI PER OGNI TIPO  
DI TERRENO E IMPIEGO

WIDE RANGE OF TIRES  
FOR EVERY TYPE  
OF GROUND AND WORK

STANDARD

MICHELIN  
445/70 R 22.5



OPTION A

CONTINENTAL / MITAS  
MPT 445/65



OPTION B

ALLIANCE 18 PR  
600/50 331



OPTION C

TRELLEBORG  
650/45 T440



OPTION D

NOKIAN COUNTRY KING  
600/50 R 22,5 10F





## OPTIONAL



Kit fari di lavoro a led  
Led working light kit

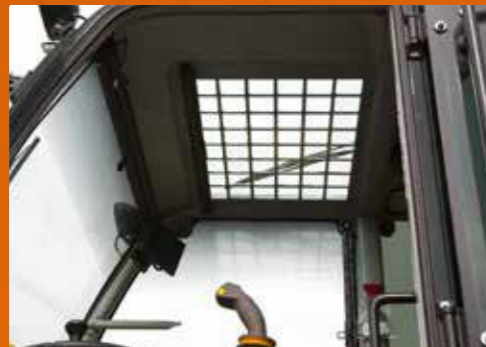

Oblò in cabina  
Cabin porthole



Telecamera retromarcia  
Reverse gear camera



Zavorra mobile con gradino  
Moving ballast with step

# DIMENSIONS

## DIMENSIONI E PESO / DIMENSIONS AND WEIGHT

<b>A</b> Lunghezza / Length	mm 5410
<b>B</b> Larghezza / Width	
• Pneumatici / Tires 445 mm	mm 2405
• Pneumatici / Tires 600 mm	mm 2520
• Pneumatici / Tires 650 mm	mm 2540
<b>C</b> Altezza / Height	mm 3990
<b>D</b> Passo / Wheelbase	mm 2500
Peso macchina senza attrezzi / Machine weight without equipment	kg 13800

## VERSIONE CON BRACCIO F12 / VERSION WITH ARM F12

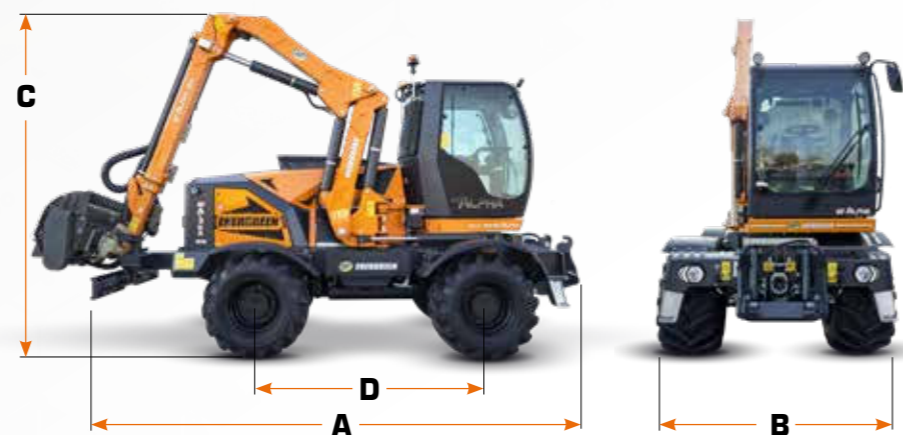

# TECHNICAL DATA

## CABINA / CABIN

Cabina girevole / Rotating cabin	Fino a 90° / up to 90°
Volante / Steering wheel	Regolabile / Adjustable
Manipolatore multifunzione / Joystick	Elettronico / Electronic
Aria condizionata / Air conditioning	Elettronica / Electronic
Vetri posteriori cabina / Rear glasses	Oscurati / Darkened anti UV
Porta cabina / Cabin door	Divisibile / Openable 60-40
Sedile regolabile / Adjustable seat	Pneumatico / Air suspension
Presa elettrica servizi / Power socket	12 V
Staccabatterie / Battery switch	Automatico / Automatic
Omologazione cabina / Cabin homologation	FOPS-ROPS

## MOTORE / ENGINE

Marca / Brand	John Deere 4.5 4045CI
Modello / Type	4 Cilindri Diesel / 4 Cylinders Diesel
Potenza / Power	173 hp (129 kW)
Iniezione / Injection	Common Rail - 4 valvole / 4 valves
Emissioni / Exhaust emissions	EU 2016/1628 Stage V
Alternatore / Alternator	200 A.
Pre-riscaldamento aria aspirazione / Pre-heating air engine intake	
Radiatore intercooler aria-aria / Air intercooler radiator	
Radiatore rinforzato liquido refrigerante / Reinforced cooler radiator	
Ventola reversibile autopulente / Self-cleaning reversible fan	FLEXAIRE®
Capacità carburante / Fuel tank capacity	245 litri / litres
Capacità AdBlue / AdBlue capacity	23 litri / litres

## IMPIANTO IDRAULICO / HYDRAULIC SYSTEM

Circuito chiuso / Closed circuits	Testata trinciante / Cutting head	Pistoni / Piston
	Traslazione / Translation pump	Pistoni / Piston
Circuito aperto / Open circuits	Movimenti braccio / Arm movement	Ingranaggi / Gear - Optional: Pistoni / Piston
	Impianto freni / Brakes system	Ingranaggi / Gear
	Impianto sterzo / Steering system	Ingranaggi / Gear
Distributore idraulico / Hydraulic distributor		6/7 sezioni / sections
Portata olio attrezzatura / Oil flow attachment		160 l/min
Pressione olio attrezzatura / Oil pressure attachment		290 bar

## TRASMISSIONE E FRENI / TRANSMISSION AND BRAKES

Trasmissione / Transmission	Idrostatica / Hydrostatic	
Trazione / Traction	2x4 - 4x4	
Variazione velocità / Speed variation	0 - 40 km/h	
Cambio meccanico / Manual gearbox	2 rapporti / 2 gears	
Allineamento ruote / Wheel alignment	Elettronico / Electronic	
Asse anteriore / Front axle	Oscillante / Oscillating	
	Bloccaggio / Front axle block	Idraulico / Hydraulic
Assi sterzanti / Steering axles		2 assi / 2 axles
Bloccaggio differenziale anteriore / Front axle block		100%
Bloccaggio differenziale posteriore / Rear axle block		100%
Freno stazionamento / Parking brake		Negativo / Negative
Freni di servizio / Service brakes		8 dischi / 8 discs





**ILF ALPHA**

f Instagram B YouTube in **ENERGREEN.IT**



# SELF-PROPELLED HYDROSTATIC MACHINES



Concessionario di zona - Local dealership



**ENERGREEN**®

Professional Machines

Via Sabbioni, 16 · 36026 Cagnano di Pojana Maggiore (VI) · Italy  
Tel. +39 0444 1511200 · Fax +39 0444 1511252 · [www.energreen.it](http://www.energreen.it) · [commerciale@energreen.it](mailto:commerciale@energreen.it)

MACCHINE E ATTREZZATURE PROFESSIONALI  
PROFESSIONAL MACHINES AND EQUIPMENT



EIEDP-180101 - 0721 - © Energreen 2021 - Tutti i diritti riservati - Foto, caratteristiche tecniche e costruttive soggette a modifica senza obbligo di notifica - All rights reserved - Photo, technical and constructive characteristics subjected to modification without reporting requirement.